



Member of **PKF** International

Audit and Automation

Using Forms to make life easier

6th May 2021



Outline

- Audit and Caseware IDEA
- Concerns for audit
- Scripting & Forms



Follow us:



JOHNSTON
CARMICHAEL 

A bit about me

Andrew Davidson

BSc PhD CMath MIMA CA CISA

IT Audit Senior Manager

Andrew.Davidson@jcca.co.uk



- Used to be a researcher in Mathematical models for display technologies.
- Retrained as a Chartered Accountant in a Big 4 Professional Services company.
- Focused on IT Audit and technology services.
- Joined Johnston Carmichael 6 years ago to develop their IT Audit and Data analytics services.
- Now branching into Vulnerability assessment.



Follow us:



JOHNSTON
CARMICHAEL 

Audit and Caseware IDEA

Some key areas

- Sales Completeness
- Fixed Assets
- Inventory
- Payroll
- Process accuracy (for when system controls are weak)



• Journals

Follow us:



Audit and Caseware IDEA

Success stories

- Sales Completeness – typical results

Sales records from system:	8252	Value £10,780,157.44
Items matching to nominal:	8188	Value £10,418,344.79
Sales not noted in nominal:	16	Value £1,803.45
Missing credit notes:	33	Value £324,872.62
Unmatched	15	Value £35,136.58
Total Reconciled		Value £10,780,157.44

Follow us:



Audit and Caseware IDEA

Success stories

Relationships are not always simply 1 to 1.

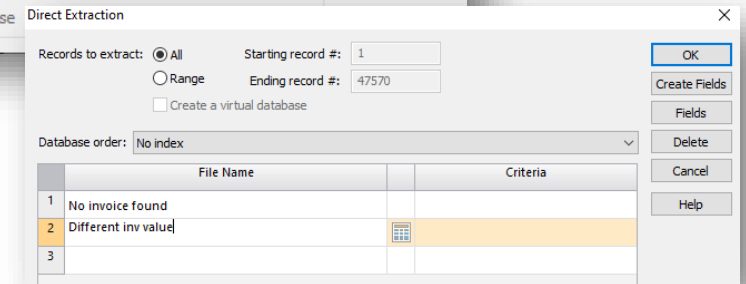
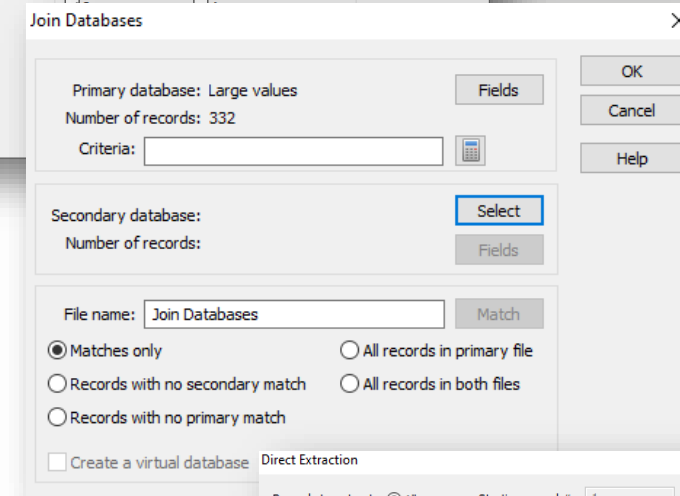
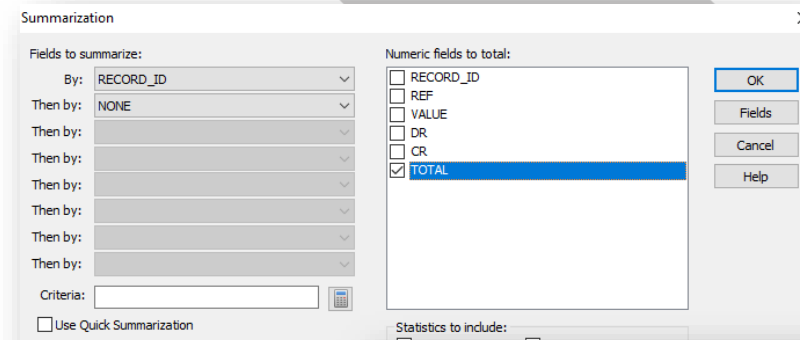
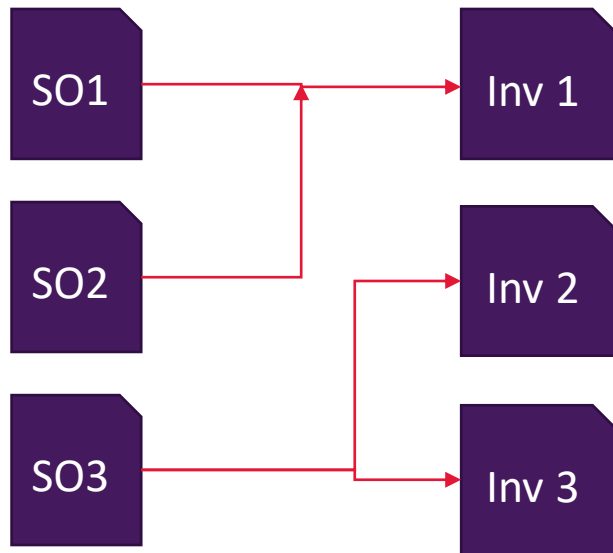

Audit and Caseware IDEA

Purchases

The Audit team wanted comfort that all purchase orders raised resulted in a corresponding invoice paid for the correct amount.

The risk was that some purchases hadn't been fulfilled or companies had been paid by invoice without purchase order being raised.

Purchase records:	51,203 (~£365M)
Invoice records:	152,882
Gaps in PO's:	1419
PO's not matched to invoices during the year:	1
Total difference in value	£2.86

Follow us:



Audit and Caseware IDEA

Payroll

Duplicate bank details

Unusual activity

Paid twice in same period

Unusual / missing bank account info

Paid £0

Left and re-joined

Changed bank account

etc

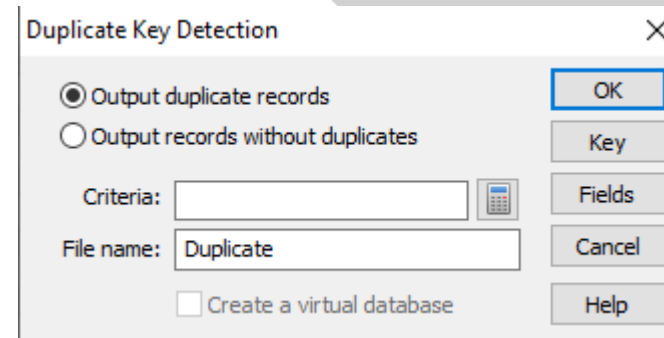

Example results:

- 20+ staff sharing the same bank account
- Initial concern over fraudulent activity
- Summer holiday staff sharing bank accounts
- Business was unaware of situation
- Risk of modern slavery

Follow us:



Audit and Caseware IDEA

Process mapping

Map through of timesheets testing

IDEA Script

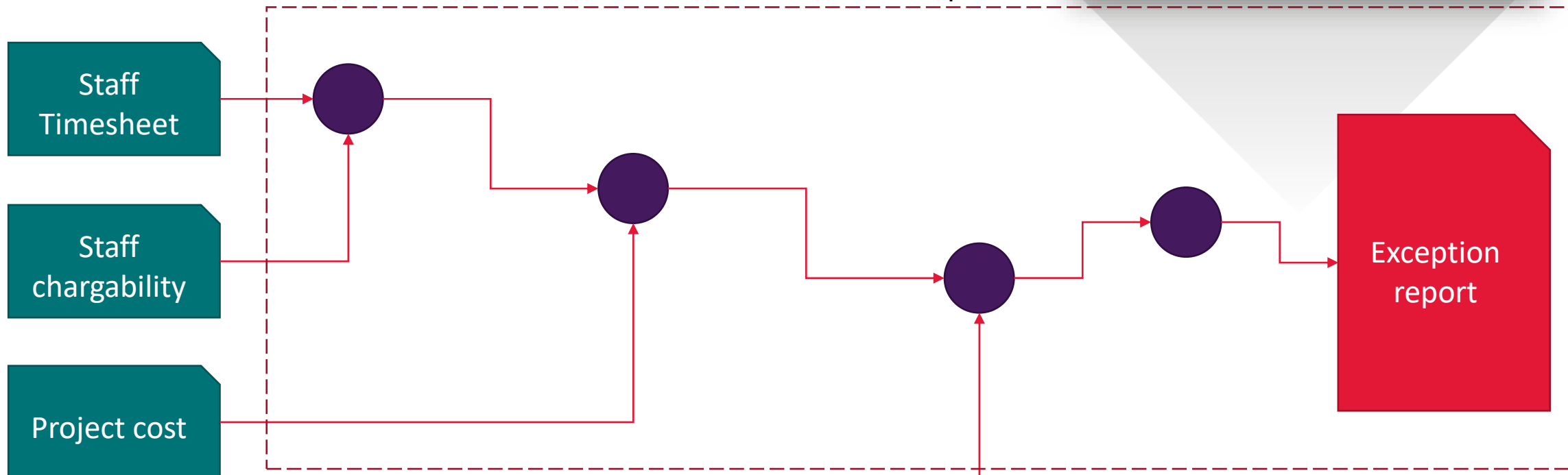
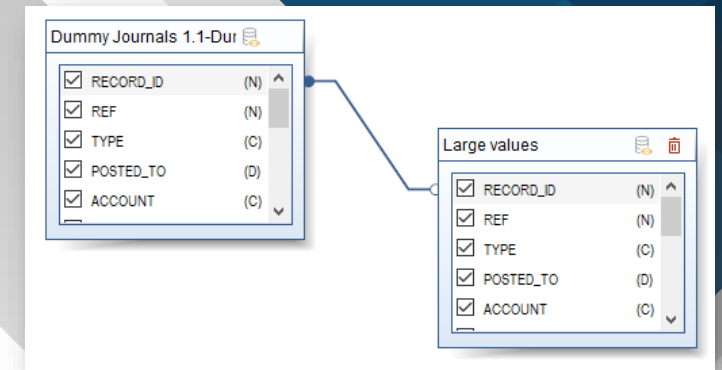

Nominal ledger

Audit concerns

Reperformability

“Any audit process should be able to be re-performed 100%”

Sampling

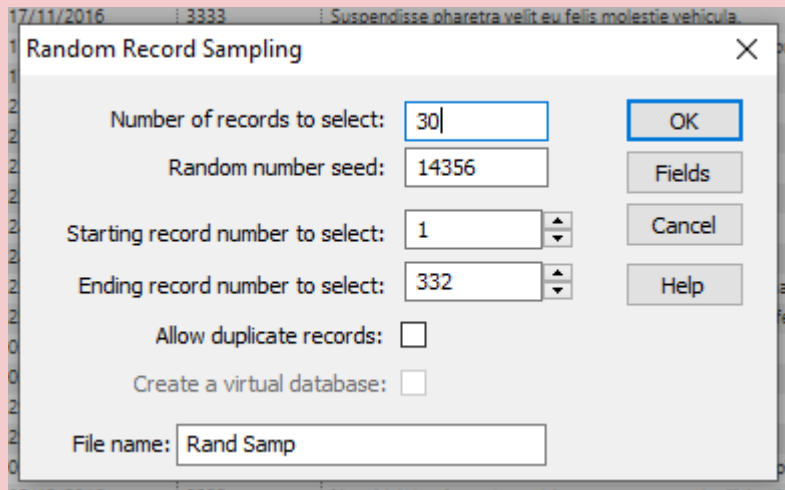

Scripting

```
Set db = Client.OpenDatabase("Dummy Journals 1.1-Dummy Journals.IMD")
```

```
Set task = db.Extraction
```

```
task.IncludeAllFields
```

```
dbName = "Large values.IMD"
```

```
task.AddExtraction dbName, "", "TOTAL >= 50000
```

```
.OR. TOTAL <= -50000"
```

```
task.CreateVirtualDatabase = False
```

```
task.PerformTask 1, db.Count
```

```
Set task = Nothing
```

```
Set db = Nothing
```

```
Client.OpenDatabase (dbName)
```

Follow us:



JOHNSTON
CARMICHAEL



Year on year challenges

- New staff

Need to be trained

lack of consistent use = retraining required

Need them up and running fast

- Manager / Partner review

They need to see what you did

Many might find it hard to understand



Follow us:



JOHNSTON
CARMICHAEL



Forms - Demo

Follow us:



Summary

- IDEA is an essential tool for us in Audit
- Scripting and Forms allow quick and consistent approach
- We can get new staff up and running quickly

Thanks for listening

Follow us:





Member of **PKF** International

Where sharp minds meet

Johnston Carmichael
227 W George St, Glasgow G2 2ND
info@jcca.co.uk

jcca.co.uk

